



Push-In Fitting Type Flame-Retardant Spatter-proof Speed Controller Speed Controller **Anti-spatter Series**



- *Adopting Flame-Retardant Resin (V-O).*
- *Protective Cover to Protect from Sparks.*
- *Effective Combination with Anti-spatter Tube.*

CONTROLLER

VALVE

TUBE

MAKE-TO-ORDER
PRODUCTS

422

Anti-spatter
Series

Constant Flow
Series

Throttle Needle
Valve Series

Stainless
Series

PP
Series

Anti-spatter
Series

Quick Exhaust
Valve Series

Exhaust
Valve Series

Fixed orifice
Series

Pressure Control
Series

Pressure Gauge
Series

Check Valve
Series

Silencer
Series

Model Designation (Example)

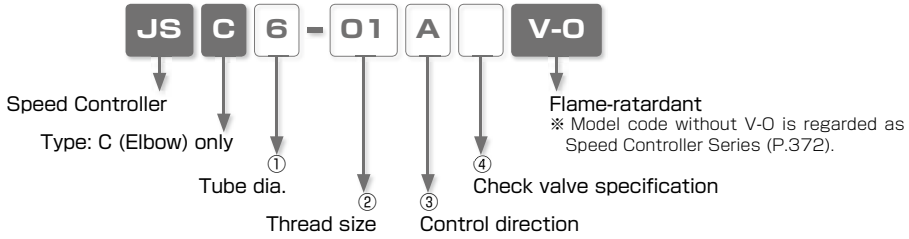

① Tube dia.

Code	4	6	8	10	12
Size(mm)	ø4	ø6	ø8	ø10	ø12

② Thread size

Thread size	Metric thread (mm)	Taper pipe thread			
Code	M5	01	02	03	04
Size	M5 × 0.8	R1/8	R1/4	R3/8	R1/2

③ Control direction

Code	A	B
Control direction	<p>Meter-out</p> <p>■ Air from thread side is controlled. Air from tube side is not controlled and flows out from thread side.</p>	<p>Meter-in</p> <p>■ Air from tube side is controlled. Air from thread side is not controlled and flows out from tube side.</p>
Identification	"A" is marked on the top of needle. Locknut color: Silver	"B" is marked on the top of needle. Locknut color: Black

④ Check valve specification

No code : Standard

K : Low cracking pressure type (Check valve cracking pressure: 0.02MPa, operating pressure range: 0.05~0.5MPa)

※ "K" is marked on the top of needle.

Specifications

Fluid medium	Air
Operating pressure range	0.1 ~ 0.9MPa (Low cracking pressure type : 0.05 ~ 0.5MPa)
Check valve cracking pressure	0.05MPa (Low cracking pressure type : 0.02MPa)
Operating temp. range	0~60°C (No freezing)

Construction



Symbol

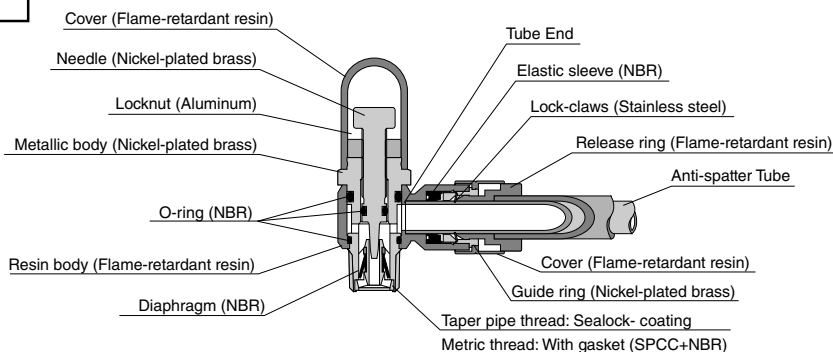

△ Detailed Safety Instructions

Before using PISCO products, be sure to read "Safety Instructions" and "Safety Instruction Manual" on page 23 to 27 and "Common Safety Instructions for Controllers" on page 367 to 368.

Warning

1. When controlling the speed of actuators, slowly release the air by adjusting the needle from a fully closed state. In case the needle is opened, actuator can move suddenly. Turn needle in the clockwise direction to close, and in the counterclockwise to open.
2. Do not swing or rotate resin body of the products by force. It may damage to the products and cause a fluid leakage.

Caution

1. Speed controller permits some air leakage. Do not use the products for the application which requires no leakage.
2. Make sure to use Cover after adjusting the speed of actuator. There is a possibility that flame and weld spatters cause malfunction of the operation without cover.
3. When using Anti-spatter Tube, peel the cover as the following table shows. It may cause the escape of a tube, a fluid leakage or even impossible to insert the tube into Push-In Fitting, if the tube is not peeled properly.

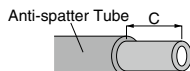

Tube dia.	ø4mm	ø6mm	ø8mm	ø10mm	ø12mm
Peeled length(C)	15.5mm	16.5mm	17.5mm	20mm	23.5mm

※ PISCO product Anti-spatter Tube Cover Peeler" can help you to peel the cover easily.

How to adjust the speed

1. Speed adjustment of actuators

① Increasing speed

Turn the needle in the counterclockwise direction from a fully closed state. The more the needle is opened, the faster the actuator moves. Make sure to tighten the locknut at the desired speed.

The speed setting can be changed without tightening the locknut.

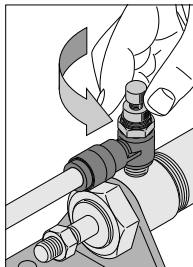

② Reducing speed

Turn the needle in the clockwise direction when the speed is too fast. Make sure to tighten the locknut at the desired speed. The speed setting can be changed without tightening the locknut.

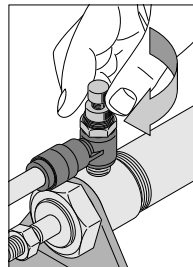

How to attach and detach cover

1. Cover attachment and detachment

① Cover detachment

Pinch the cover and pull it up while swinging it right and left as the right figure shows.



② Cover attachment

Push the cover down until it stops.

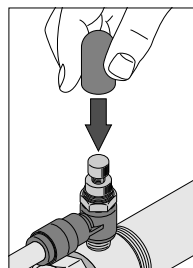

How to insert and disconnect

1. How to insert and disconnect tubes

① .Tube insertion

Insert a tube into Push-In Fitting up to the tube end. Lock-claws bite the tube and fix it automatically, then the elastic sleeve seals around the tube.

Refer to "2. Instructions for Insertion" under "Common Safety Instructions for Fittings" .

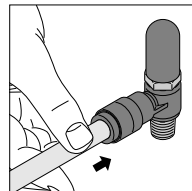

② .Tube disconnection

The tube is disconnected by pushing release-ring to release Lock-claws.

Make sure to stop air supply before the tube disconnection.

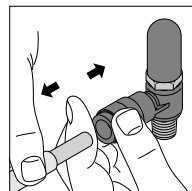

2. How to tighten thread

① .Tightening thread

Use a spanner to tighten a hexagonal-column.

Refer to "Table: Recommended tightening torque" under "2. Instructions for Installing Controllers" in "Common Safety Instructions for Controllers" .

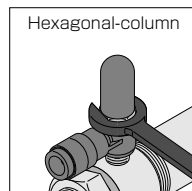

Applicable Tube and Related Products

Anti-spatter Tube... P.646

Anti-spatter Tube Cover Peeler... P.664

Tube Fitting Anti-spatter Series... P.204

Controller Series

Speed Controller Anti-spatter

FITTING
CONTROLLER

JSC Elbow
V-0

RoHS compliant

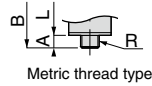
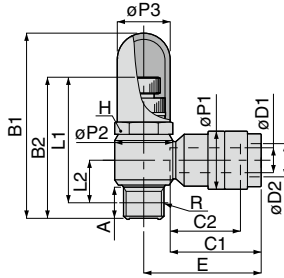

Unit : mm

Model code	Tube O.D. øD1	Tube O.D. øD2	R	A	B1	B2		L1		L2	øP1	øP2	øP3	Tube end C1	Tube end C2	E	Hex. H	Weight (g)
						max.	min.	max.	min.									
JSC4-M5□(K)V-0	4	6	M5×0.8	2.9	32.2	29.7	27	26.8	24.1	7.3	12	9.8	10	20	15	25	8	9.8
JSC4-01□(K)V-0			R1/8	8	43.9	40.7	34.4	36.7	30.4	10.7		14.4	12.8		26.5	12	21	
JSC6-M5□(K)V-0	6	8	M5×0.8	2.9	32.2	29.7	27	26.8	24.1	8.5	14	9.8	10	22.1	17.1	29.1	8	11
JSC6-01□(K)V-0			R1/8	8	43.9	40.7	34.4	36.7	30.4	10.9		14.4	12.8			28.6	12	22
JSC6-02□(K)V-0			R1/4	11.1	51.5	47.8	41.4	41.8	35.4	12.2		18.4	16			30.6	16	42
JSC6-03□V-0			R3/8	13.2	58.6	53.7	46.5	47.3	40.1	15.4		22	19.2			34.1	22	70
JSC8-01□(K)V-0	8	10	R1/8	8	43.9	40.7	34.4	36.7	30.4	11.9	16	14.4	12.8	23.3	18.3	32.1	12	24
JSC8-02□(K)V-0			R1/4	11.1	51.5	47.8	41.4	41.8	35.4	13.2		18.4	16			33.6	16	43
JSC8-03□V-0			R3/8	13.2	58.6	53.7	46.5	47.3	40.1	15.4		22	19.2			34.1	22	71
JSC8-04□V-0			R1/2	16	64.2	59.3	52.3	51.1	44.1	18		28	19.2			36.2	27	107
JSC10-02□(K)V-0	10	12	R1/4	11.1	51.5	47.8	41.4	41.8	35.4	14.8	19	18.4	16	25.4	20.4	36.1	16	46
JSC10-03□V-0			R3/8	13.2	58.6	53.7	46.5	47.3	40.1	16.7		22	19.2			36.4	22	74
JSC10-04□V-0			R1/2	16	64.2	59.3	52.3	51.1	44.1	18		28	19.2			38.8	27	110
JSC12-03□V-0			R3/8	13.2	58.6	53.7	46.5	47.3	40.1	18.4		22	28			41.9	22	78
JSC12-04□V-0	12	14	R1/2	16	64.2	59.3	52.3	51.1	44.1	19.7	22.2	28	19.2	28.4	23.4	41.3	27	114

※ "L1" and "L2" are reference values for height dimensions after tightening taper thread.

※ □ in Model code / Replaced with " A " for Meter-out, " B " for Meter-in

As for the above model code with (K), when selecting "Low cracking pressure type" (Check valve cracking pressure: 0.02MPa), () is removed from the model code.

427

Speed Controller Series
Stainless Series
PP Series
Anti-spatter Series



Flow characteristic

Elbow

JSC 4-M5KV-0
6-M5KV-0

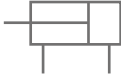

Cylinder tube I.D.
Max. ϕ **16**mm

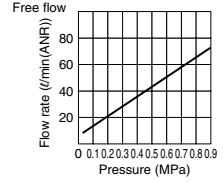
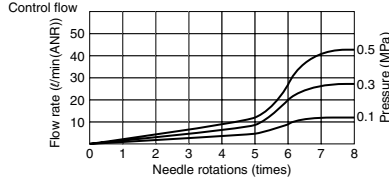

JSC 4-M5V-0
6-M5V-0

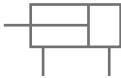

Cylinder tube I.D.
Max. ϕ **20**mm

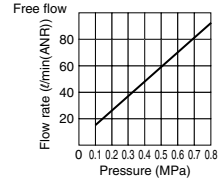
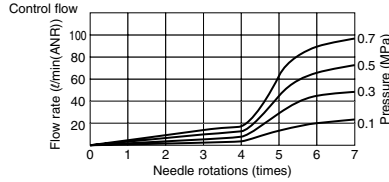

JSC 4-01V-0
6-01V-0
8-01V-0

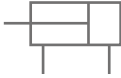

Cylinder tube I.D.
Max. ϕ **32**mm

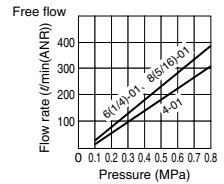
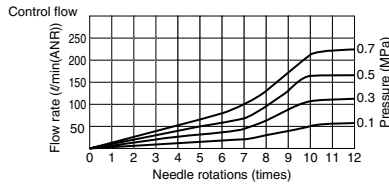

JSC 6-02 V-0

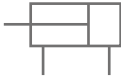

Cylinder tube I.D.
Max. ϕ **40**mm

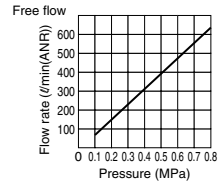
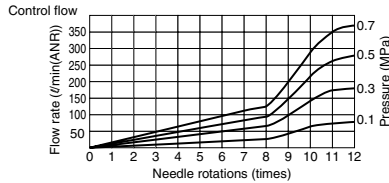

JSC 8-02 V-0
10-02 V-0

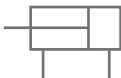

Cylinder tube I.D.
Max. ϕ **40**mm

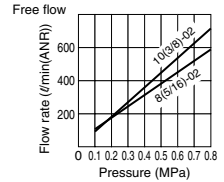
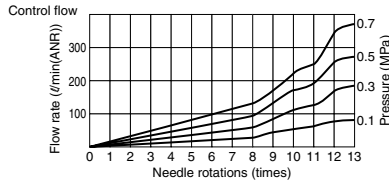

JSC 6-03 V-0



Cylinder tube I.D.
Max. ϕ **63**mm

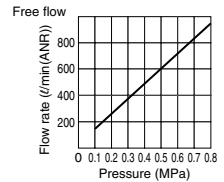
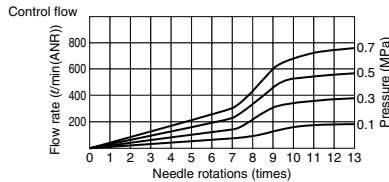

JSC 8-03 V-0

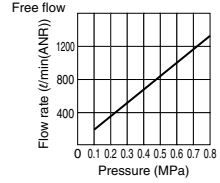
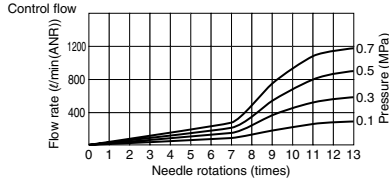
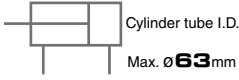

JSC 10-03 V-0

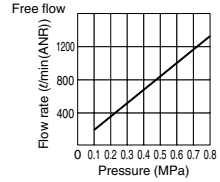
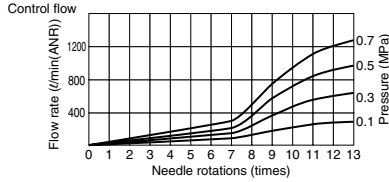
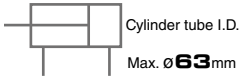

JSC 12-03 V-0

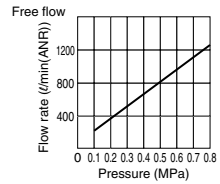
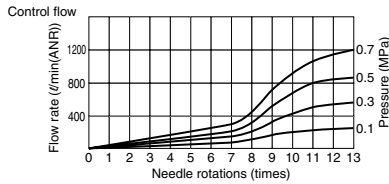
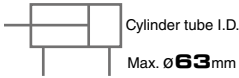

JSC 8-04 V-0

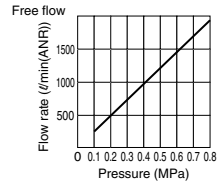
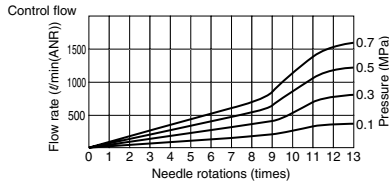
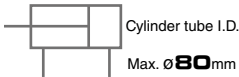

JSC 10-04 V-0

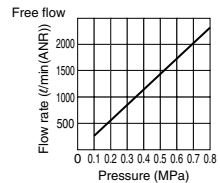
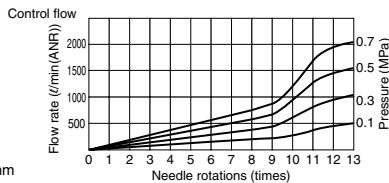
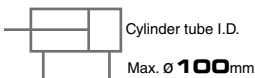

JSC 12-04 V-0

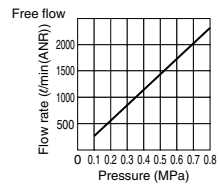
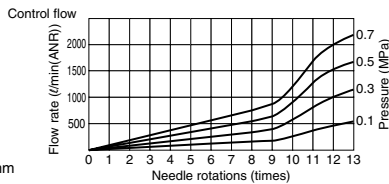
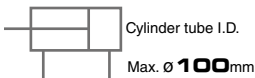



SAFETY Instructions

This safety instructions aim to prevent personal injury and damage to properties by requiring proper use of PISCO products.

Be certain to follow ISO 4414 and JIS B 8370

ISO 4414 : Pneumatic fluid power...Recommendations for the application of equipment to transmission and control systems.

JIS B 8370 : General rules and safety requirements for systems and their components.

This safety instructions is classified into "Danger", "Warning" and "Caution" depending on the degree of danger or damages caused by improper use of PISCO products.



Danger

Hazardous conditions. It can cause death or serious personal injury.



Warning

Hazardous conditions depending on usages. Improper use of PISCO products can cause death or serious personal injury.



Caution

Hazardous conditions depending on usages. Improper use of PISCO products can cause personal injury or damages to properties.



Warning

1. Selection of pneumatic products

- ① A user who is a pneumatic system designer or has sufficient experience and technical expertise should select PISCO products.
- ② Due to wide variety of operating conditions and applications for PISCO products, carry out the analysis and evaluation on PISCO products. The pneumatic system designer is solely responsible for assuring that the user's requirements are met and that the application presents no health or safety hazards. All designers are required to fully understand the specifications of PISCO products and constitute all systems based on the latest catalog or information, considering any malfunctions.

2. Handle the pneumatic equipment with enough knowledge and experience

- ① Improper use of compressed air is dangerous. Assembly, operation and maintenance of machines using pneumatic equipment should be conducted by a person with enough knowledge and experience.

3. Do not operate machine / equipment or remove pneumatic equipment until safety is confirmed.

- ① Make sure that preventive measures against falling work-pieces or sudden movements of machine are completed before inspection or maintenance of these machine.
- ② Make sure the above preventive measures are completed. A compressed air supply and the power supply to the machine must be off, and also the compressed air in the systems must be exhausted.
- ③ Restart the machines with care after ensuring to take all preventive measures against sudden movements.

Disclaimer

1. PISCO does not take any responsibility for any incidental or indirect loss, such as production line stop, interruption of business, loss of benefits, personal injury, etc., caused by any failure on use or application of PISCO products.
2. PISCO does not take any responsibility for any loss caused by natural disasters, fires not related to PISCO products, acts by third parties, and intentional or accidental damages of PISCO products due to incorrect usage.
3. PISCO does not take any responsibility for any loss caused by improper usage of PISCO products such as exceeding the specification limit or not following the usage the published instructions and catalog allow.
4. PISCO does not take any responsibility for any loss caused by remodeling of PISCO products, or by combinational use with non-PISCO products and other software systems.
5. The damages caused by the defect of Pisco products shall be covered but limited to the full amount of the PISCO products paid by the customer.



SAFETY INSTRUCTION MANUAL

PISCO products are designed and manufactured for use in general industrial machines. Be sure to read and follow the instructions below.

Danger

1. Do not use PISCO products for the following applications.
 - ① Equipment used for maintaining / handling human life and body.
 - ② Equipment used for moving / transporting human.
 - ③ Equipment specifically used for safety purposes.

Warning

1. Do not use PISCO products under the following conditions.
 - ① Beyond the specifications or conditions stated in the catalog, or the instructions.
 - ② Under the direct sunlight or outdoors.
 - ③ Excessive vibrations and impacts.
 - ④ Exposure / adhere to corrosive gas, inflammable gas, chemicals, seawater, water and vapor. *
* Some products can be used under the condition above(④), refer to the details of specification and condition of each product.
2. Do not disassemble or modify PISCO products, which affect the performance, function, and basic structure of the product.
3. Turn off the power supply, stop the air supply to PISCO products, and make sure there is no residual air pressure in the pipes before maintenance and inspection.
4. Do not touch the release-ring of push-in fitting when there is a working pressure. The lock may be released by the physical contact, and tube may fly out or slip out.
5. Frequent switchover of compressed air may generate heat, and there is a risk of causing burn injury.
6. Avoid any load on PISCO products, such as a tensile strength, twisting and bending. Otherwise, there is a risk of causing damage to the products.
7. As for applications where threads or tubes swing / rotate, use Rotary Joints, High Rotary Joints or Multi-Circuit Rotary Block only. The other PISCO products can be damaged in these applications.
8. Use only Die Temperature Control Fitting Series, Tube Fitting Stainless SUS316 Series, Tube Fitting Stainless SUS316 Compression Fitting Series or Tube Fitting Brass Series under the condition of over 60°C (140° F) water or thermal oil. Other PISCO products can be damaged by heat and hydrolysis under the condition above.
9. As for the condition required to dissipate static electricity or provide an antistatic performance, use EG series fitting and antistatic products only, and do not use other PISCO products. There is a risk that static electricity can cause system defects or failures.
10. Use only Fittings with a characteristic of spatter-proof such as Anti-spatter or Brass series in a place where flame and weld spatter is produced. There is a risk of causing fire by sparks.
11. Turn off the power supply to PISCO products, and make sure there is no residual air pressure in the pipes and equipment before maintenance. Follow the instructions below in order to ensure safety.
 - ① Make sure the safety of all systems related to PISCO products before maintenance.
 - ② Restart of operation after maintenance shall be proceeded with care after ensuring safety of the system by preventive measures against unexpected movements of machines and devices where pneumatic equipment is used.
 - ③ Keep enough space for maintenance when designing a circuit.
12. Take safety measures such as providing a protection cover if there is a risk of causing damages or fires on machine / facilities by a fluid leakage.

⚠ Caution

1. Remove dusts or drain before piping. They may get into the peripheral machine / facilities and cause malfunction.
2. When inserting an ultra-soft tube into push-in fitting, make sure to place an Insert Ring into the tube edge. There is a risk of causing the escape of tube and a fluid leakage without using an Insert Ring.
3. The product incorporating NBR as seal rubber material has a risk of malfunction caused by ozone crack. Ozone exists in high concentrations in static elimination air, clean-room, and near the high-voltage motors, etc. As a countermeasure, material change from NBR to HNBR or FKM is necessary. Consult with PISCO for more information.
4. Special option "Oil-free" products may cause a very small amount of a fluid leakage. When a fluid medium is liquid or the products are required to be used in harsh environments, contact us for further information.
5. In case of using non-PISCO brand tubes, make sure the tolerance of the outer tube diameter is within the limits of Table 1.

● Table 1. Tube O.D. Tolerance

mm size	Nylon tube	Polyurethane tube	inch size	Nylon tube	Polyurethane tube
ø1.8mm	—	± 0.05mm	ø1/8	± 0.1mm	± 0.15mm
ø3mm	—	± 0.15mm	ø5/32	± 0.1mm	± 0.15mm
ø4mm	± 0.1mm	± 0.15mm	ø3/16	± 0.1mm	± 0.15mm
ø6mm	± 0.1mm	± 0.15mm	ø1/4	± 0.1mm	± 0.15mm
ø8mm	± 0.1mm	± 0.15mm	ø5/16	± 0.1mm	± 0.15mm
ø10mm	± 0.1mm	± 0.15mm	ø3/8	± 0.1mm	± 0.15mm
ø12mm	± 0.1mm	± 0.15mm	ø1/2	± 0.1mm	± 0.15mm
ø16mm	± 0.1mm	± 0.15mm	ø5/8	± 0.1mm	± 0.15mm

6. Instructions for Tube Insertion

- ① Make sure that the cut end surface of the tube is at right angle without a scratch on the surface and deformations.
- ② When inserting a tube, the tube needs to be inserted fully into the push-in fitting until the tubing edge touches the tube end of the fitting as shown in the figure below. Otherwise, there is a risk of leakage.

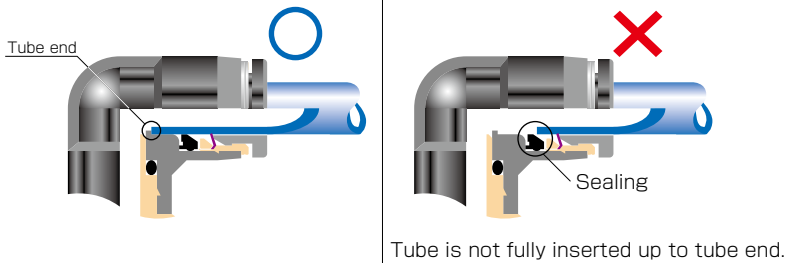

- ③ After inserting the tube, make sure it is inserted properly and not to be disconnected by pulling it moderately.
- ※ When inserting tubes, Lock-claws may be hardly visible in the hole, observed from the front face of the release-ring. But it does not mean the tube will surely escape. Major causes of the tube escape are the followings;
 - ① Shear drop of the lock-claws edge
 - ② The problem of tube diameter (usually small)
 Therefore, follow the above instructions from ① to ③, even lock-claws is hardly visible.

7. Instructions for Tube Disconnection

- ① Make sure there is no air pressure inside of the tube, before disconnecting it.
- ② Push the release-ring of the push-in fitting evenly and deeply enough to pull out the tube toward oneself. By insufficient pushing of the release-ring, the tube may not be pulled out or damaged by scratch, and tube shavings may remain inside of the fitting, which may cause the leakage later.

8. Instructions for Installing a fitting

- ① When installing a fitting, use proper tools to tighten a hexagonal-column or an inner hexagonal socket. When inserting a hex key into the inner hexagonal socket of the fitting, be careful so that the tool does not touch lock-claws. The deformation of lock-claws may result in a poor performance of systems or an escape of the tube.
- ② Refer to Table 2 which shows the recommended tightening torque. Do not exceed these limits to tighten a thread. Excessive tightening may break the thread part or deform the gasket and cause a fluid leakage. Tightening thread with tightening torque lower than these limits may cause a loosened thread or a fluid leakage.
- ③ Adjust the tube direction while tightening thread within these limits, since some PISCO products are not rotatable after the installation.

● Table 2: Recommended tightening torque / Sealock color / Gasket materials

Thread type	Thread size	Tightening torque	Sealock color	Gasket materials
Metric thread	M3 × 0.5	0.7N·m	—	SUS304 NBR
	M5 × 0.8	1.0 ~ 1.5N·m		
	M6 × 1	2 ~ 2.7N·m		
	M3 × 0.5	0.5 ~ 0.6N·m		POM
	M5 × 0.8	1 ~ 1.5N·m		
	M6 × 0.75	0.8 ~ 1N·m		
Taper pipe thread	M8 × 0.75	1 ~ 2N·m	White	—
	R1/8	7 ~ 9N·m		
	R1/4	12 ~ 14N·m		
	R3/8	22 ~ 24N·m		
Unified thread	R1/2	28 ~ 30N·m	—	SUS304, NBR
	No.10-32UNF	1.0 ~ 1.5N·m		
National pipe thread taper	1/16-27NPT	7 ~ 9N·m	White	—
	1/8-27NPT	7 ~ 9N·m		
	1/4-18NPT	12 ~ 14N·m		
	3/8-18NPT	22 ~ 24N·m		
	1/2-14NPT	28 ~ 30N·m		

※ These values may differ for some products. Refer to each specification as well.

9. Instructions for removing a fitting

- ① When removing a fitting, use proper tools to loosen a hexagonal-column or an inner hex bolt.
- ② Remove the sealant stuck on the mating equipment. The remained sealant may get into the peripheral equipment and cause malfunctions.

10. Arrange piping avoiding any load on fittings and tubes such as twist, tensile, moment load, shaking and physical impact. These may cause damages to fittings, tube deformations, bursting and the escape of tubes.

Common Safety Instructions for Controllers

Before selecting or using PISCO products, read the following instructions. Read the detailed instructions for individual series as well as the instructions below.

Warning

1. Some products have an air direction to control. Make sure to distinguish the direction by marking on the products. Installing the product with the wrong direction may cause personal injury or property damage.
2. Avoid any load on PISCO products such as a tensile strength, twisting, bending, dropping and excessive impacts. These may cause damage to the products.
3. Locknut needs to be tightened by hand. Do not use any tool. Using tools to tighten the locknut may cause damage to the products. Also, inadequate tightening may loosen the locknut and the initial setting can be changed.
4. Use clean air to supply. Dusts and sludge may result in the change of the initial setting.

⚠ Caution

1. Refer to “Common Safety Instructions for Fittings” for the safety instructions for fitting part.
2. Instructions for Installing Controllers
 - ① Use proper tools to tighten a hexagonal-column or a knurling, when installing the controller.
 - ② Refer to the following table which shows the recommended tightening torque to tighten thread. Excessive tightening may break the thread part or deform the gasket to cause a fluid leakage. Tightening thread with the tightening torque lower than these limits may cause a loosened thread or a fluid leakage.

● Table: Recommended tightening torque (hexagonal-column)

Thread type	Thread size	Tightening torque
Metric thread	M3 × 0.5	0.7Nm
	M5 × 0.8	1 ~ 1.5Nm
	M6 × 1	2 ~ 2.7Nm
Taper pipe thread	R1/8	7 ~ 9Nm
	R1/4	12 ~ 14Nm
	R3/8	22 ~ 24Nm
	R1/2	28 ~ 30Nm
Unified thread	No.10-32UNF	1.5 ~ 1.9Nm
National pipe thread taper	1/16-28NPT	7 ~ 9Nm
	1/8-27NPT	7 ~ 9Nm
	1/4-18NPT	12 ~ 14Nm
	3/8-18NPT	22 ~ 24Nm
	1/2-14NPT	28 ~ 30Nm
Parallel pipe thread	G3/8	After hand tightening 1/2~1 turns
	G1/2	

(knurling)

Thread type	Thread size	Tightening torque
Metric thread	M5 × 0.8	1/6 turns after hand tightening
	M6 × 1	
	M10 × 1	
Parallel pipe thread	G3/8	1/2~1 turns after hand tightening
	G1/2	

3. Instructions for removing Controller

- ① When removing controllers, use proper tools to loosen a hexagonal-column or a knurling.
- ② Remove the sealant stuck on the mating equipment. The remained sealant may get into the peripheral equipment and cause malfunctions.

4. Fixed Orifice Joint Series and Speed Controller Constant Flow Series have deviation of flow rate. Contact us, in case a very accurate amount of flow rate is required.

5. If PISCO products generate heat by an adiabatic compression, total temperature including the heat from the product must be controlled within the range of the specification.