

MVAA-460 series

PILOT VALVE

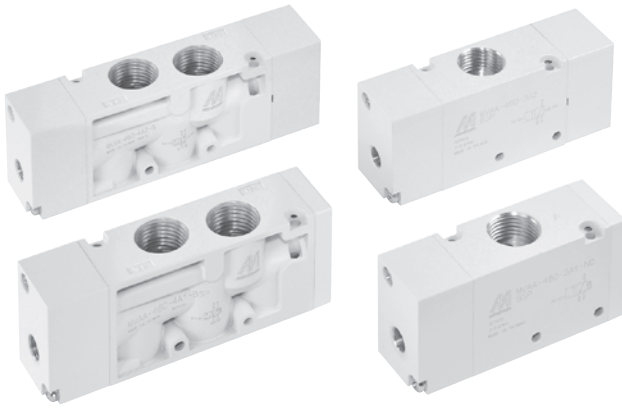

Specification

Model	3A1	3A2	4A1	4A2	4A2C.PR
Bore No.	15A				
Port size	1/2				
No. of port	3		5		
Medium	Air				
Operating pressure range	0~0.8 MPa				
Proof pressure	1 MPa				
Effective orifice	50 mm ²				
Pilot pressure range	(0.34×P*+0.1)~0.8 MPa				
Ambient temperature	-5~+60°C (No freezing)				
Weight	300 g	326 g	275 g	338 g	410 g

* P: Operating pressure.

Order example of valve

MVAA – 460 – 4A2C – NC – NPT

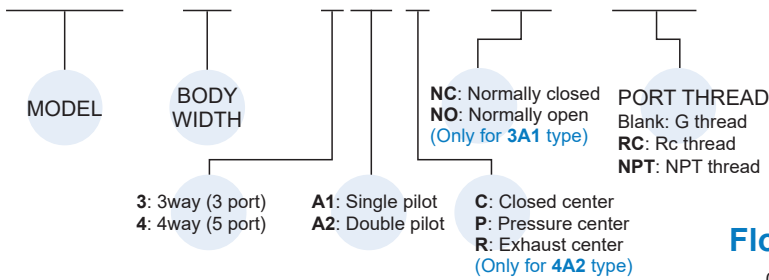

Order example of manifold

MVSC – 460 – 5B3 – NPT

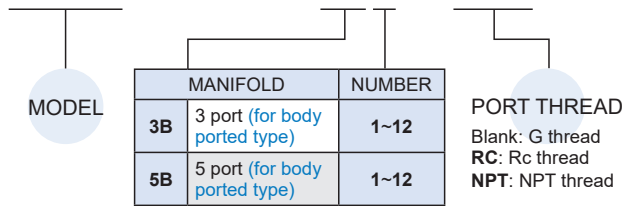

* Use the same manifold with MVSC.

* Starting from 11 stations, manifolds are made to order.

* Use the same blocking plate with MVSC.

Order example of blocking plate

MVSC – 460 – 5P

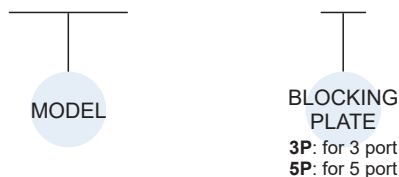

Flow features

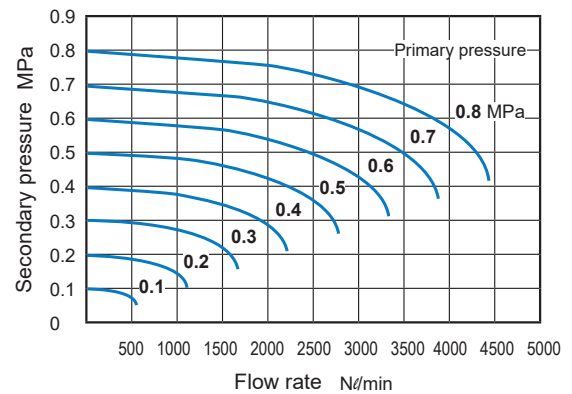

Blocking plate parts

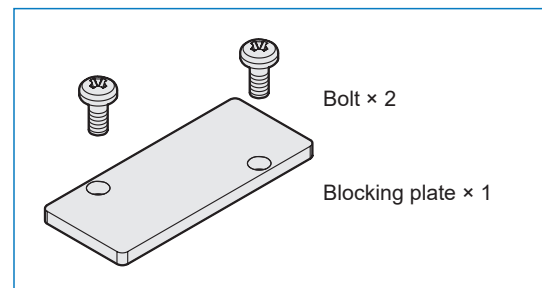

MVAA-460 Dimensions

PILOT VALVE



MVAA-460-4A1

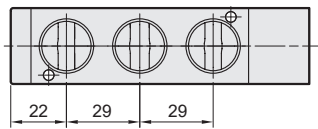
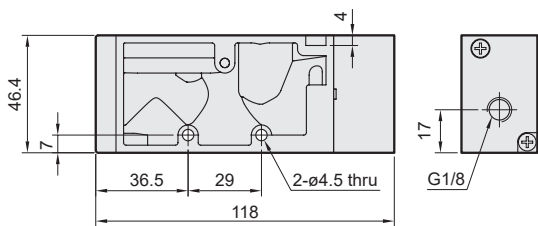
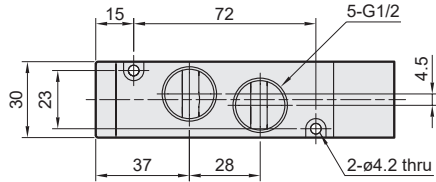
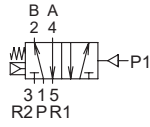

MVAA-460-4A2

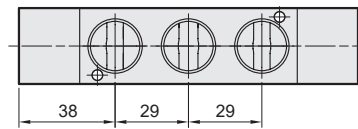
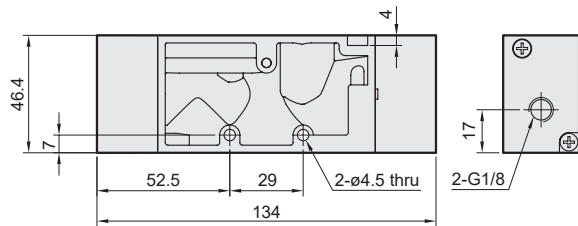
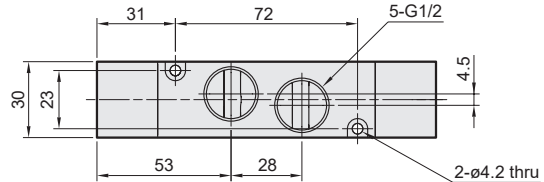
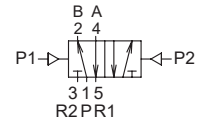

MVAA-460-4A2C.PR

MVAA-460-4A2C

MVAA-460-4A2P

MVAA-460-4A2R

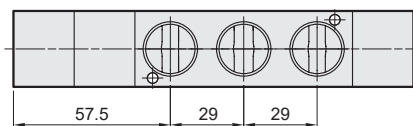
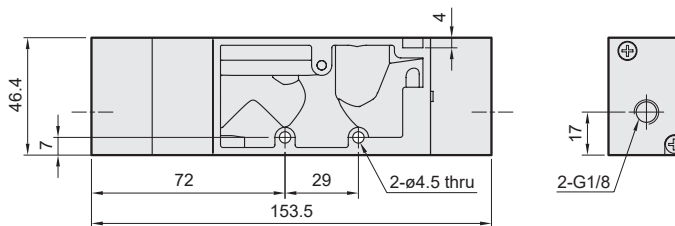
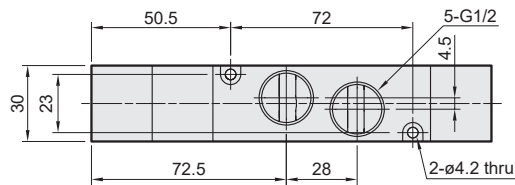
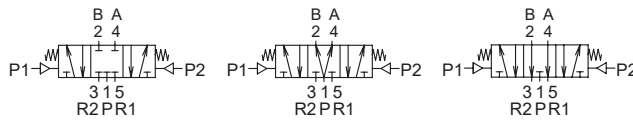

MVAA-460 Dimensions

PILOT VALVE



MVAA-460-3A1-NC/NO

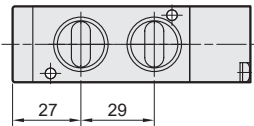
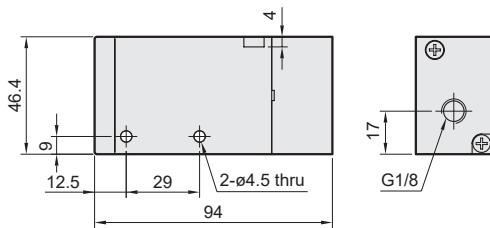
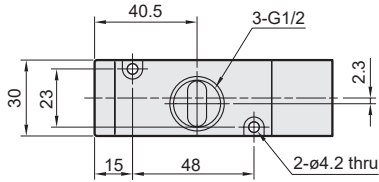
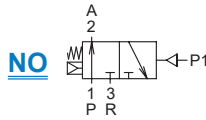
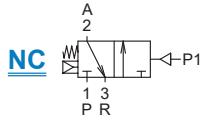

MVAA-460-3A2

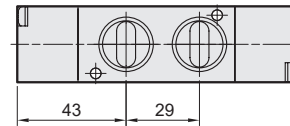
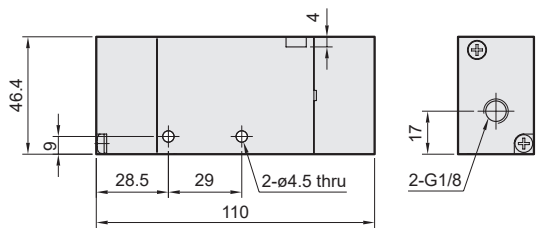
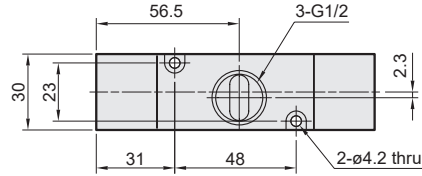
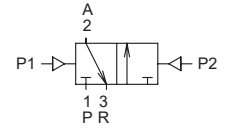

Manifold of pilot valve

MVSC-460-3B*

* Use the same manifold with MVSC.

3 port (for body ported type)

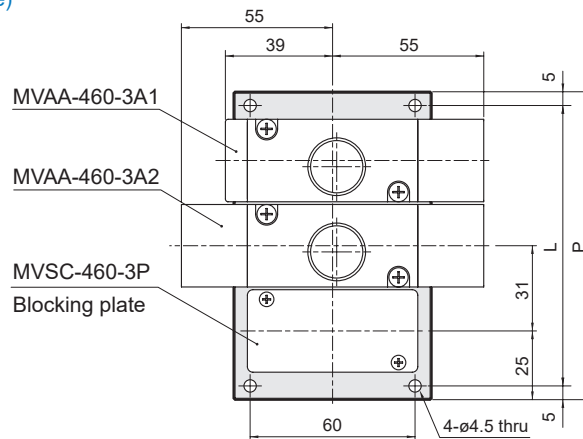

No. of stations	P	L
1	40	50
2	71	81
3	102	112
4	133	143
5	164	174
6	195	205
7	226	236
8	257	267
9	288	298
10	319	329

P: (No. of stations-1)×31+40
L: (No. of stations-1)×31+50

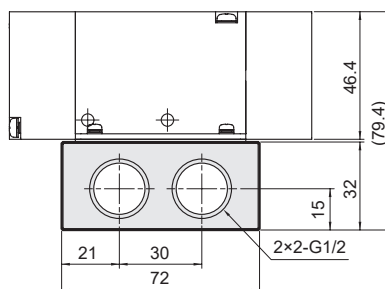

MVAA-460 Manifold

PILOT VALVE



MVSC-460-5B*

* Use the same manifold with MVSC.

5 port (for body ported type)

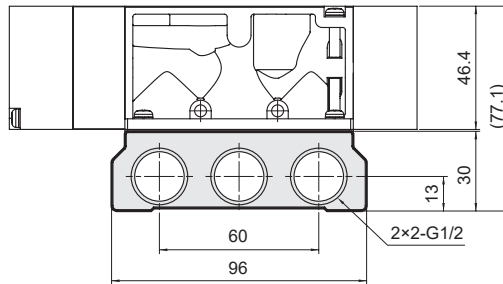
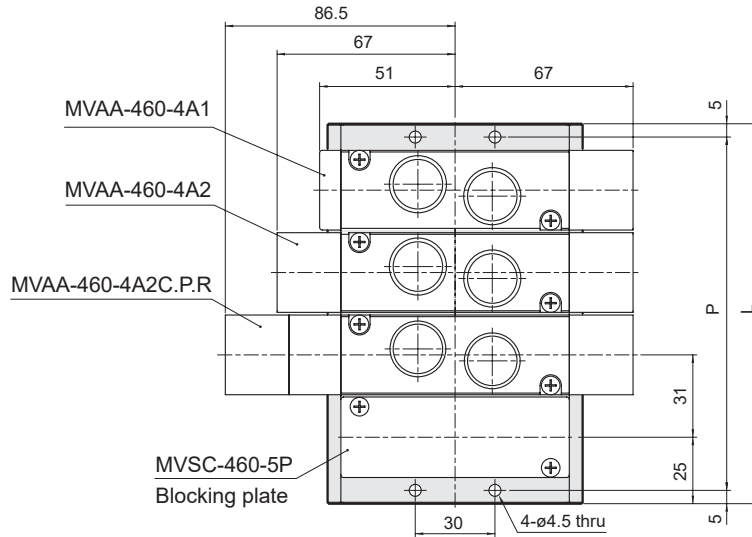

No. of stations	P	L
1	40	50
2	71	81
3	102	112
4	133	143
5	164	174
6	195	205
7	226	236
8	257	267
9	288	298
10	319	329

P: (No. of stations-1)×31+40

L: (No. of stations-1)×31+50