

14 Setting the OFF Time

(Interval) cont.

1. Use the ⊕ and the ⊖ buttons to adjust the minutes.
2. Press **SET** to continue.
3. Use the ⊕ and the ⊖ buttons to adjust the hours.
4. Press **SET** to continue.

15 Setting the Days

The following screen will then appear:



You must select the days you wish the irrigation Window to operate.

1. Press **SET** to reach the day you wish to irrigate. The number (corresponding to the day of the week) will flash.
2. Press ⊕ to select that day (the square which appears indicates day is selected).
3. Press ⊖ to deselect day.
4. Press **SET** until all days are programmed as desired. Current day continues flashing.
5. Press **SET** to complete programming.

16 Example

You have just received a new batch of chicks, and a heat wave is forecasted. You need to cool the chicken coop with short bursts (one minute) of the sprinkler system, every half hour, from 8am until 6pm. Make sure the clock is set, and the day of the week is also set.

Press **MODE** twice to get to Window start time screen (**Str**). Set this screen to 08:00. **End** screen then appears. Set **End** to 18:00. The next screen is the **On** screen (Duration Time). Set this to 1 minute. The **Off** (Interval) screen should be set to 30 minutes.

Each day of the week should then be selected on the next screen.

The controller is now programmed and will turn on the system for one minute, every half hour, between 8am and 6pm, until the controller is turned **Off**, or the program changed.

17 Off season

During the season when you do not need to water your plants, press the **MODE** button quickly until **OFF** is displayed. **DO NOT** remove the battery. The controller is equipped with a back-up battery, and removing the main battery for long periods will cause the back-up battery to discharge.

FLOW CHART for G75 Irrigation Window Controller

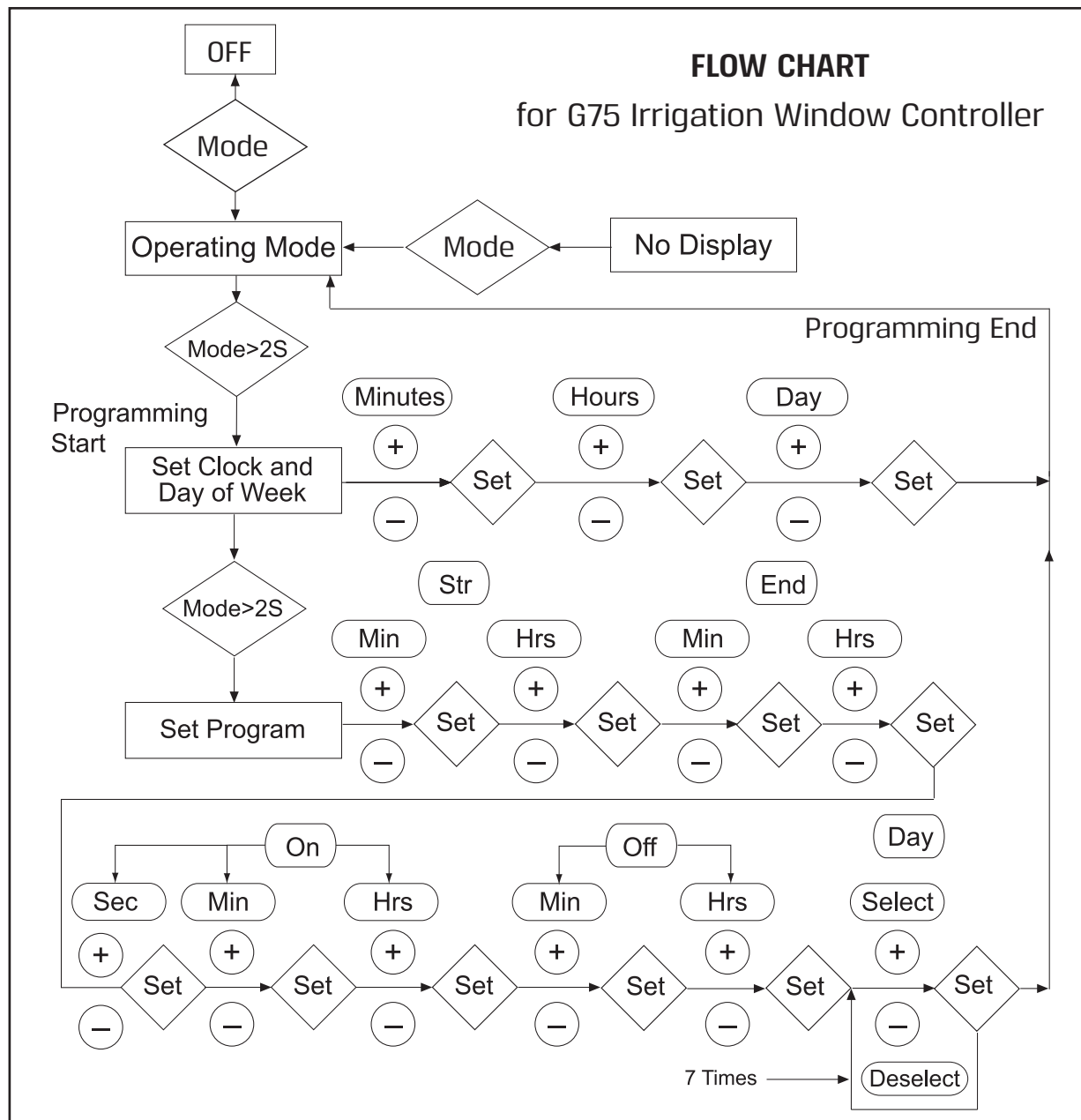

18 Maintenance

Battery Installation

Replace the battery at the start of each irrigation season and when the low battery symbol appears.

1. Using a Phillips screw driver, remove the four battery cover screws.
2. Remove the battery cover and seal.
3. Replace the battery.
4. After reattaching the seal, put the cover back, and secure with the four screws.

19

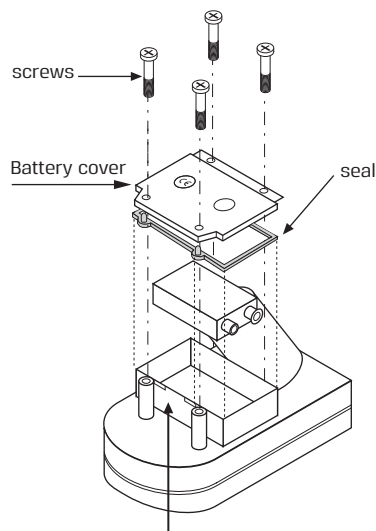

When replacing the seal, push seal tabs into slots.

20 Troubleshooting

Problem	Cause	Solution
Controller does not irrigate plants as desired	Water at main faucet is shut off	Check faucet
	Hose cut or blocked	Replace damaged section
	Battery dead	Replace battery
	Controller set on OFF	Press MODE to activate
Blank display	Controller improperly programmed	Check program and clock settings
	Battery dead	Replace battery
Water does not turn off	Controller is sleep mode	Press MODE to activate screen
	Valve blocked by dirt or scale	Replace valve
	Valve installed backwards	Install valve so that the arrow points in the direction of the water flow.

Caution! Do not remove the battery when the controller is in use

21 Guarantee

Baccara products are guaranteed to be free from defects in material and workmanship for a period of one year from the date of delivery.

This guarantee does not apply where equipment is not used and installed strictly in accordance with Baccara specifications and Users Guide. Neither does it apply to failures caused by lightning strikes or damage due to freezing temperatures or mechanical causes (e.g. lawn mowers). Baccara is not liable for indirect, incidental or consequential damage in connection with the use of equipment.

To receive guarantee benefits, customers should return defective units along with the receipt to the nearest Baccara distributor.

Baccara reserves the right to alter, modify or redesign its products, pricing and guarantee at all times without creating any liability for the obsolescence of customer inventory of such parts or products.

This manufacturer guarantee policy may apply differently in different countries.

BACCARA®

G75 Irrigation Window and Window+ Controllers

• English



Users Guide

Baccara Geva Ltd., Kvutzat Geva 1891500, Israel
Tel. 972-4-6535-960 • Fax. 972-4-6531-445
e-mail: water@baccara-geva.com | www.baccara-geva.com

1 Getting Started

Features : This Controller irrigates in cycles, during a window of time according to your needs. New plantings may be irrigated for short bursts, in defined intervals. Cycle irrigation is also used for temperature control.

- Operates in cycles during programmed window
- Battery powered; no need for electrical hookup.
- Easy Installation
- Waterproof and weather resistant
- Easy programming

Parts Identification

1. Top cover
2. Controller display
3. Solenoid
4. Controller
5. Water flow direction arrow
6. Hydraulic valve

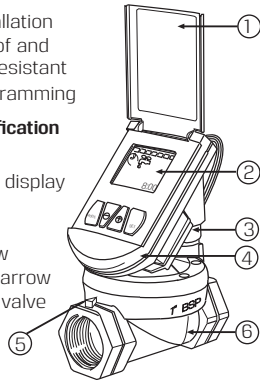

2 Basic Controller Functions

This section gives a brief description of the controller buttons. See the following sections for further details.

MODE button - Quick presses of the **MODE** button turn the controller off or on. Longer presses of the **MODE** button put the controller in programming mode.

SET button - Press the **SET** button to set a function and proceed.

⊕ ⊖ Use these buttons to increase and decrease schedule functions.

3 Installation

1. Turn off the main faucet.
2. Install the valve in the irrigation system so that the arrow on the valve is pointing in the direction of the water flow. The controller may be swiveled around to facilitate installation.
3. Occasionally the valve opens in transit. To ensure that the valve is closed before you open the main faucet, first make sure that the controller is not set to OFF (If it is set to OFF, press briefly on the **MODE** button to turn it on). Then press ⊕ and **SET** simultaneously to open, and press ⊖ and **SET** simultaneously to close. You are now ready to program the controller.
4. Turn on the main faucet.

4 Manual Operation

To manually open the valve, make sure the controller is not set to OFF (If it is set to OFF, press briefly on the **MODE** button), then press ⊕ and **SET** simultaneously. The irrigation will continue until the interval defined has passed. If the irrigation duration has been set to zero, the valve will close after one minute. To stop irrigating, press ⊖ and **SET** simultaneously.

Irrigation Cycle Table

Window Start Time						
Window End Time						
ON Time (Duration)						
OFF Time (Interval)						
Sun.	Mon.	Tue.	Wed.	Thu.	Fri.	Sat.
✓	✓	✓	✓	✓	✓	✓

5 Manual operation: Example

You have just planted new seedlings, and you wish to water them for 5 minutes, every hour, during the hottest part of the day, every day. Set your Window Start Time to 10:00; Window End Time to 14:00; ON (Duration) Time to 5 (minutes); and OFF (Interval) Time to 1:00. Your table will look like this:

Window Start Time	10:00					
Window End Time	14:00					
ON Time (Duration)	5					
OFF Time (Interval)	1:00					
Sun.	Mon.	Tue.	Wed.	Thu.	Fri.	Sat.
✓	✓	✓	✓	✓	✓	✓



6 Programming the Controller

Meaning of Controller icons

NOTE:

Quick presses of the **MODE** button turns the controller off or on. Longer presses of the **MODE** button put the controller in programming mode.

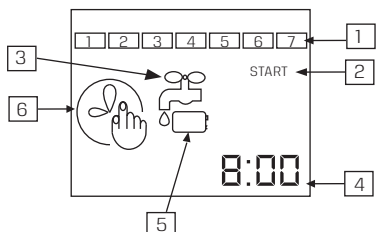

1. Irrigating days of the week
2. Cycle start (shows cycle has started).
3. Irrigation
4. Timing or clock
5. Low battery
6. Time adjustment

7

NOTE:

You cannot program the controller if it is set to manual operation (section 4) or if it is set to OFF. To release from manual operation press ⊖ and **SET** simultaneously. To release from OFF press briefly on the **MODE** button.

8 Setting the Clock

If screen is blank, press **MODE** to activate. To set the program, you must be in operating mode. Before programming the controller, you must set the clock.

1. Press **MODE** for several seconds until the time adjustment icon appears (The minutes will be flashing).

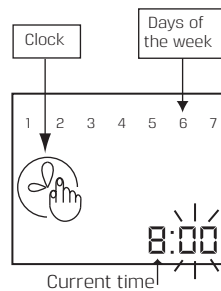

On this screen the numbers represent the current time.

10 Setting the Window (cont.)

On this screen, the clock numbers refer to the time you wish the Window to begin. **St** flashes on the screen, alternating with the numbers.

2. Use the ⊕ and the ⊖ buttons to adjust the minutes.
3. Press **SET** to continue.
4. Use the ⊕ and the ⊖ buttons to adjust the hours.
5. Press **SET** to continue.

11 Setting the Window End Time

The following screen will then appear:

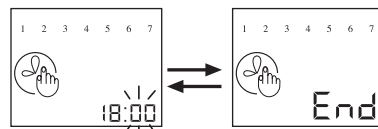

On this screen, the clock numbers refer to the time you wish the irrigation Window to end.

End flashes on the screen, alternating with the numbers.

1. Use the ⊕ and the ⊖ buttons to adjust the minutes.
2. Press **SET** to continue.
3. Use the ⊕ and the ⊖ buttons to adjust the hours.
4. Press **SET** to continue.

12 Setting the ON Time

(Duration Time)

The following screen will then appear:

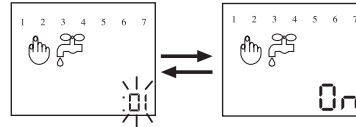

On this screen, the numbers refer to the amount of time the irrigation will be on, each time it activates within the irrigation cycle. **On** is measured in seconds, minutes and hours.

On flashes on the screen, alternating with the numbers.

1. Use the ⊕ and the ⊖ buttons to adjust the seconds.
2. Press **SET** to continue.

13

13 Setting the OFF Time (Interval)

The following screen will then appear:

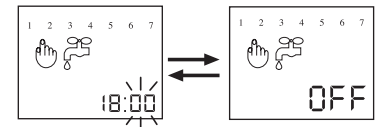

On this screen, the numbers refer to the interval between irrigations within the cycle (measured in minutes and hours).

OFF flashes on the screen, alternating with the numbers.

3. Use the ⊕ and the ⊖ buttons to adjust the minutes.
4. Press **SET** to continue.
5. Use the ⊕ and the ⊖ buttons to adjust the hours.
6. Press **SET** to continue.